

Tous droits strictement réservés. Reproduction ou communication à des tiers interdite sous quelque forme que ce soit sans autorisation écrite du propriétaire. Propriété de c FCI. Droits de reproduction FCI.

All rights strictly reserved. Reproduction or issue to third parties in any form whatever is not permitted without written authority from the proprietor. Property of FCI. Copyright FCI.

PRODUCT No.	ROWS	POWER							SIGNAL													
		E1	P1	P2	P3	P4	P5	P6	P7	1	2	3	4	5	6	7	8	9	10	11	12	E2
51601-XX001-- NOTE: 2	D C B A		PA	PA	PA	PA	X	PA	PA	UUUU	XX	XX	XX	XX	UUUUUU	XX	XX	XX	XX	SSSSSS	RRRR	

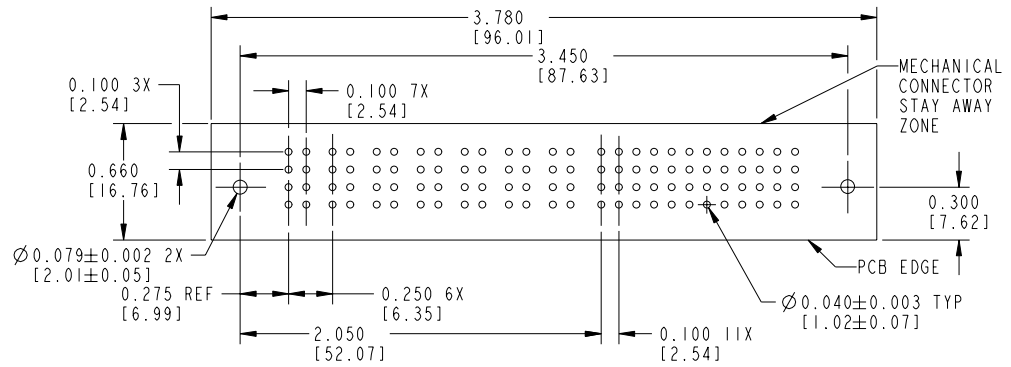
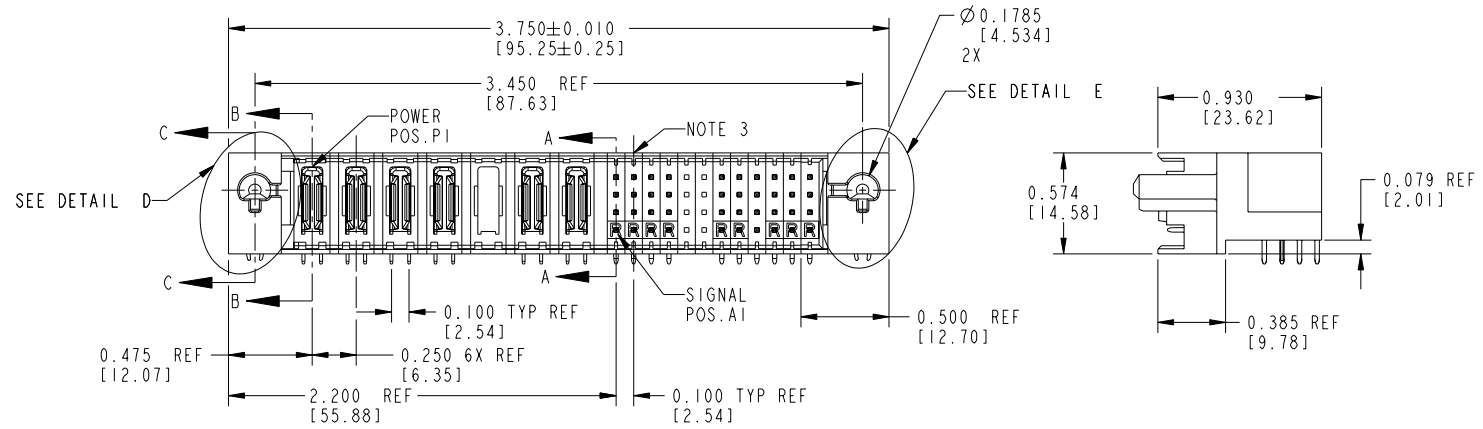

ITEM NO.	DIM "M" ±0.10 [0.25]	CONTACT TYPE
E	0.220 [5.59]	SIGNAL
H	0.220 [5.59]	SIGNAL
R	0.270 [6.86]	SIGNAL
S	0.270 [6.86]	SIGNAL
T	0.270 [6.86]	SIGNAL
U	0.270 [6.86]	SIGNAL
PA	N/A [N/A]	POWER
HA	N/A [N/A]	HOLD-DOWN

mat'l code		NOTE 1		tolerances unless otherwise specified		CUSTOMER COPY	
ltr	ecn no.	dr	date	linear	.XX±.01/.X±.3	projection	title
A	V81897	DLW	10-30-98		.XXX±.005/.X±.13		7P + 48S
B	V90098	DLW	01-22-99		.XXX±.0020/.XXX±.051		RIGHT ANGLE SOLDER HEADER
C	V94311	EKK	01-28-00	angles	0°±2°		
D	V02755	EKK	12-04-00	dr	D. WOLFORD 10-30-98	INCH / MM	product family PWRBLADE code
E	V12846	DAI	12-31-01	enr	J. BROWN 10-30-98	scale 1:1	size dwg no 213
F	DG05-0363	GJM	09/29/05	chr	J. BROWN 10-30-98		51601 SHEET 1 OF 3
G	DG06-0011	CS	01/09/06	appd	J. BROWN 10-30-98		
sheet index	revision	G	G	G			
	sheet	1	2	3			

form no. 7530-001-103

cage code 22526

Tous droits strictement réservés. Reproduction ou communication à des tiers interdite sous quelque forme que ce soit sans autorisation écrite du propriétaire. Propriété de FCI. Droits de reproduction FCI.

All rights strictly reserved. Reproduction or issue to third parties in any form whatever is not permitted without written authority from the proprietor. Property of FCI. Copyright FCI.

PRODUCT NUMBER
51601-XX001--
NOTE: 2

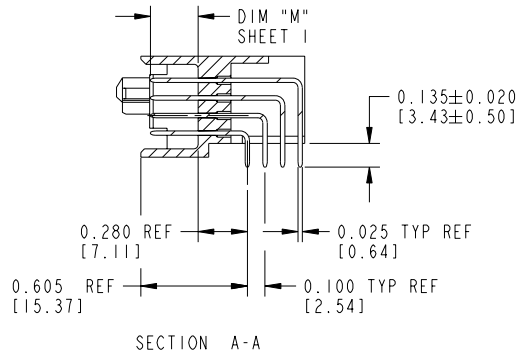

DETAIL D
SCALE 1:1
CODE H SHOWN

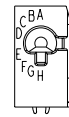

DETAIL E
SCALE 1:1
CODE 8 SHOWN

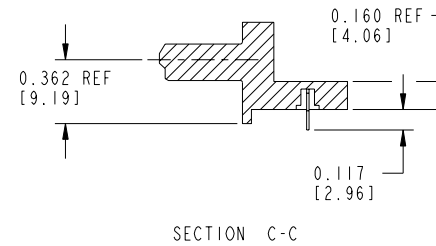
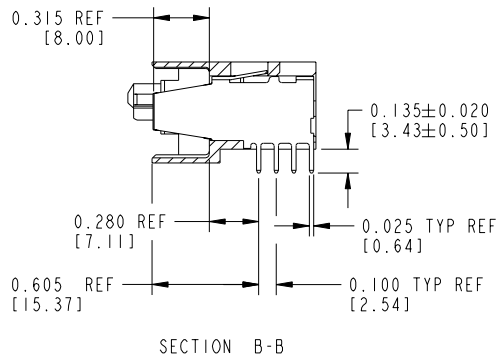
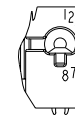

mat'l code				NOTE 1		tolerances unless otherwise specified		CUSTOMER		FCI		www.fciconnect.com	
ltr	ecn no.	dr	date	linear	.XX±.01/.X±.3	projection	INCH / MM	COPY		title		7P + 48S	
G				angles	.XXX±.005/.X±.13	INCH / MM	1:1	RIGHT ANGLE SOLDER HEADER		product family		PWRBLADE	
				dr	.XXX±.0020/.XXX±.051	scale	1:1	A		size		213	
				enr	0°±2°			A		dwg no		SHEET 2	
				chr	D. WOLFORD 10-30-98			A		51601			
				appd	J. BROWN 10-30-98			A		cage code		22526	
sheet index	revision sheet												

